

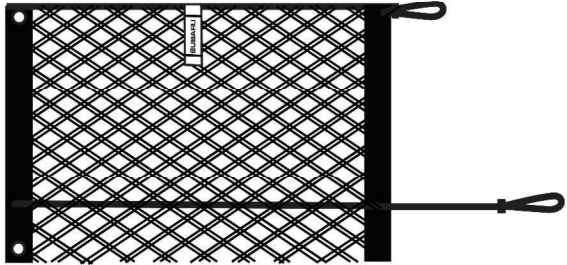

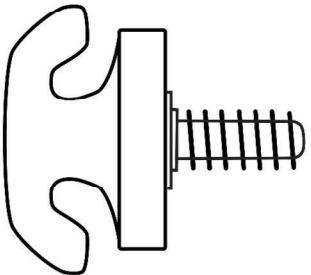

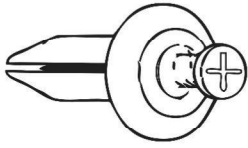





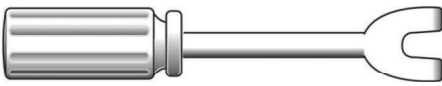



<b>INSTALLATION INSTRUCTIONS</b>	<b>SUBARU</b>	<b>PART NUMBER:</b> F551SAL020
		<b>DESCRIPTION:</b> LEGACY
	<b>SIDE NET KIT (BOTH SIDES)</b>	

<b>A</b>	<b>KIT CONTENTS:</b>	<b>2X</b>	<b>B</b>	<b>4X</b>
				
<p>Note: that this kit contains both a left and right side net</p>				

<b>C</b>	<b>4X</b>	<b>D</b>	<b>4X</b>	<b>E</b>	<b>4X</b>
		<p>Note: M5x22 OD Nylon Spacer</p> 			

<b>TOOLS REQUIRED:</b>

<b>Meaning of Characters:</b>	
 : Remove	 : Tightening Torque
 : Install	 : Loosen
 : Disconnect	 : Discard
 : Connect	 : Recyclable
 : Location of pre-arranged mark	 : View
 : Driver side rear cargo area	
 : Passenger side rear cargo area	

ISSUE 2	DATE 4/04/14	<b>SUBARU OF AMERICA</b>	PAGE 1/3
------------	-----------------	--------------------------	-------------

**1** Remove trunk mat.

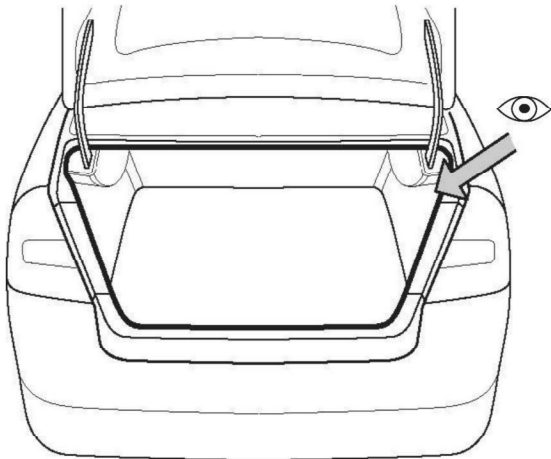

**2**  Locate trim plugs indicated.

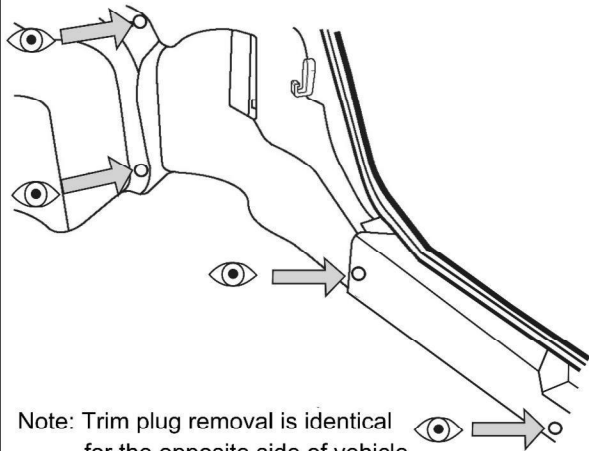

**3**  Remove trim plugs from panel and discard.

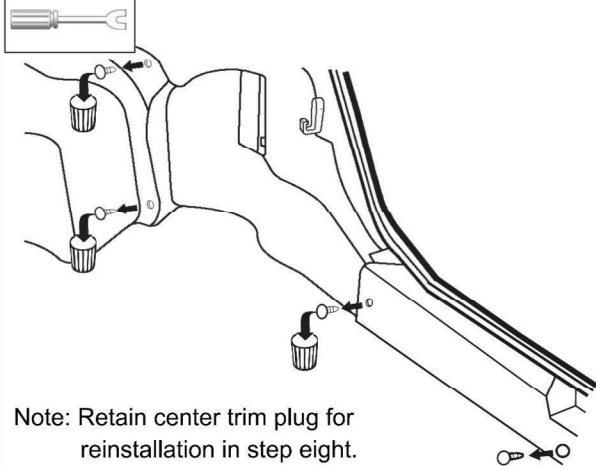

**4**  Locate hook.

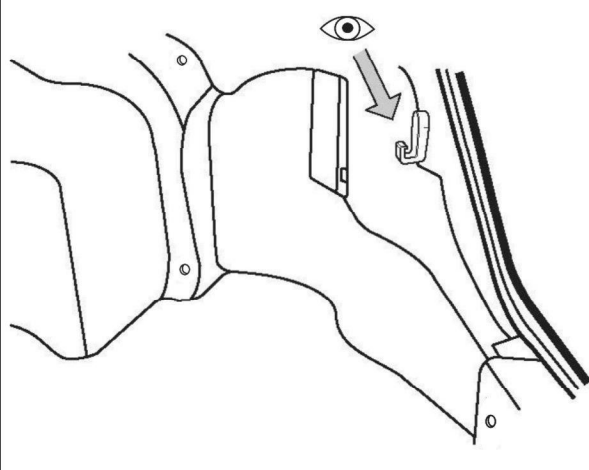

**5**  Turn hook 90 degrees first then pull straight out.

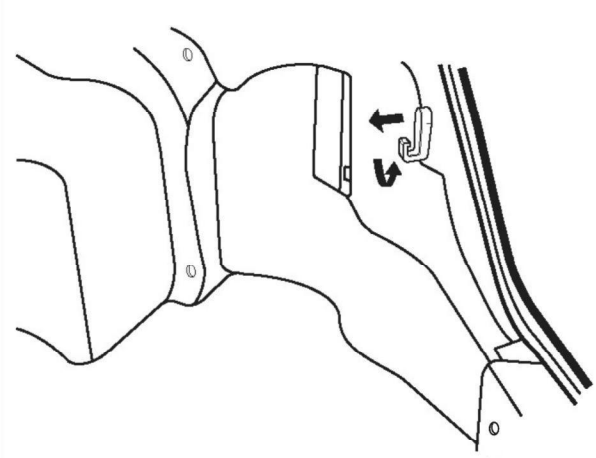

**6**  Carefully pull back side trim to access upper clip mounting point.

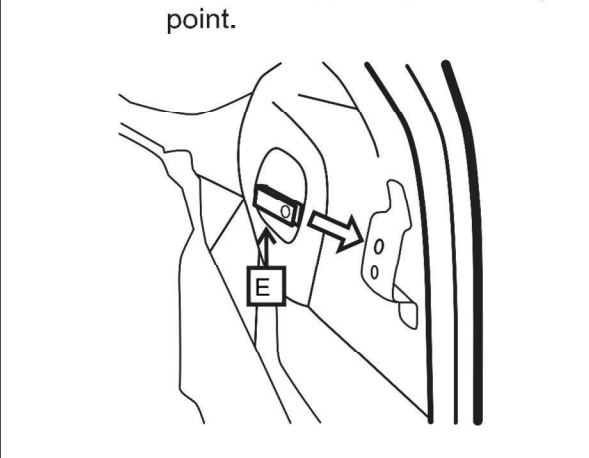

Note: Installation is identical for opposite side of vehicle.

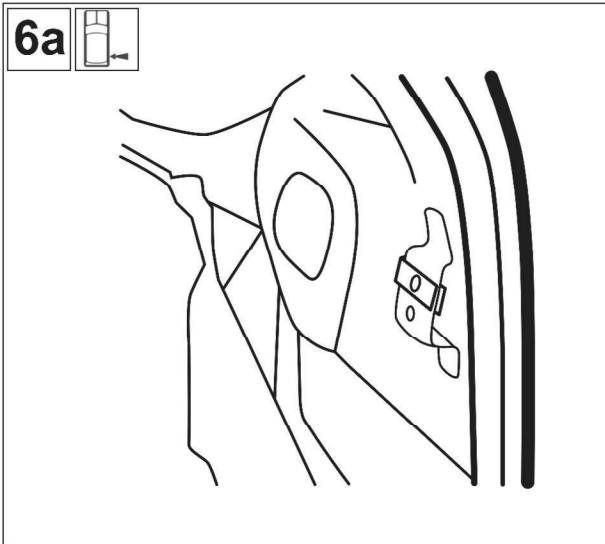
**6a****7**

Carefully remove trim panel to access lower clip mounting point.

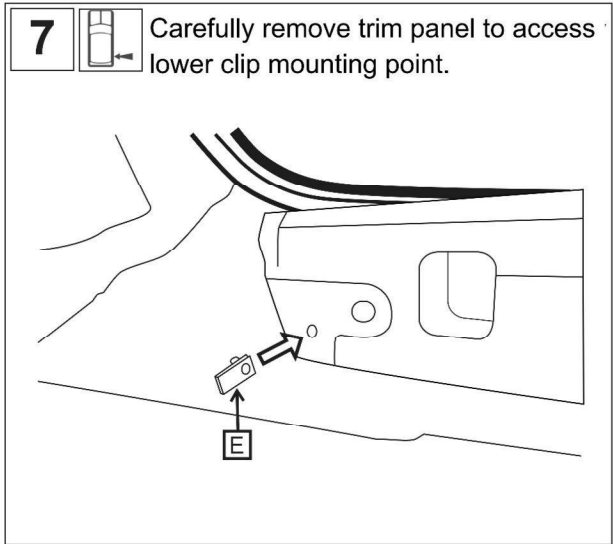
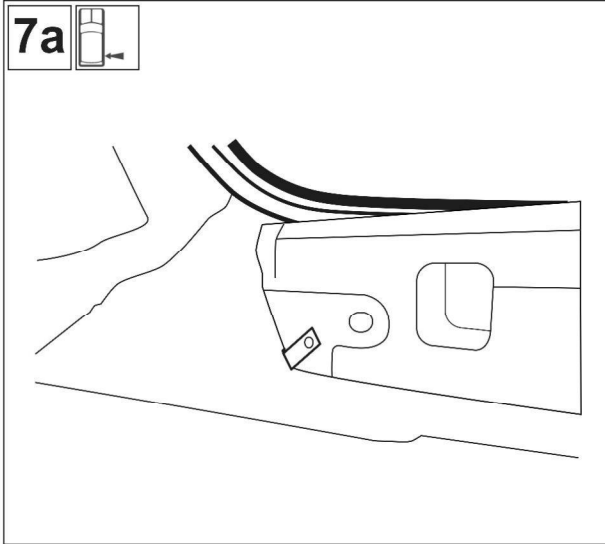
**7a****8**

Note: Reinstall side and lower trim panels and trunk mat.

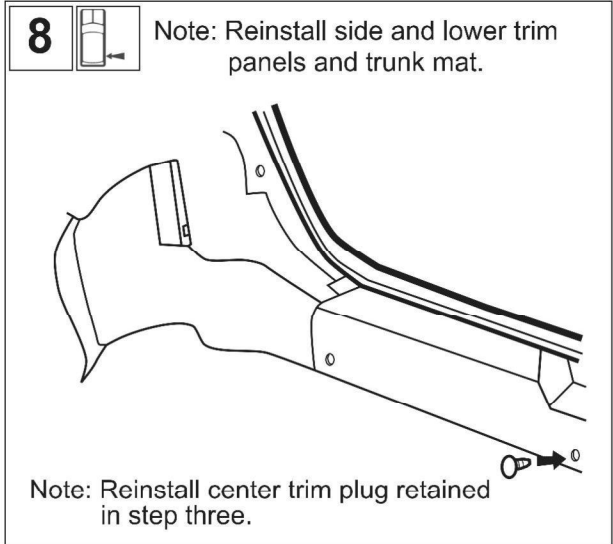
**9**

Note: Fit spacers onto the T-anchors and hand tighten until snug, in both the upper and lower mounting points as shown in the photo.

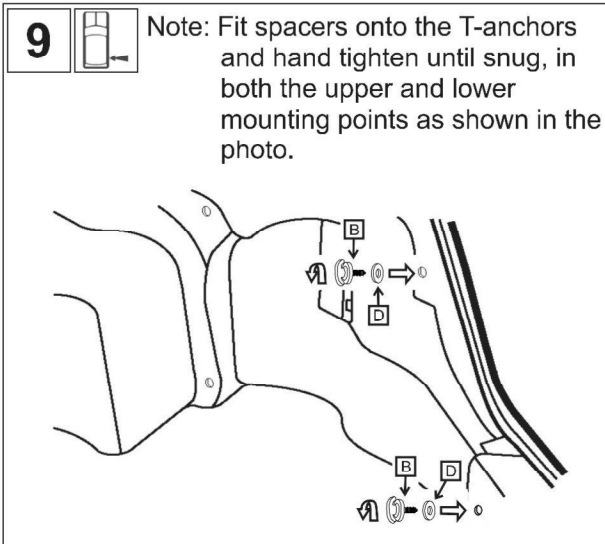

Note: Installation is identical for opposite side of vehicle.

**10**

To complete final installation,  
 a) Push each panel fastener through the webbing until secure.  
 b) Place each bungee loop around the T-Anchor shown in the photo.

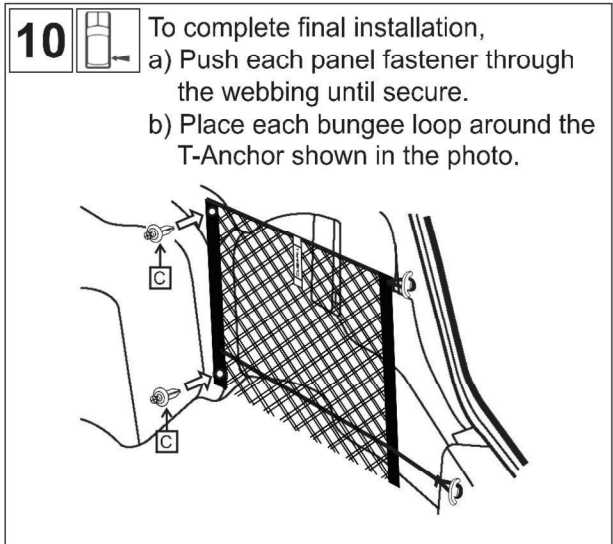

• Each net can hold up to 30 lbs. of cargo during normal driving conditions. Not intended to restrain objects during off-road use or in an accident.

**A** **CONTENU DU NÉCESSAIRE : 2X**

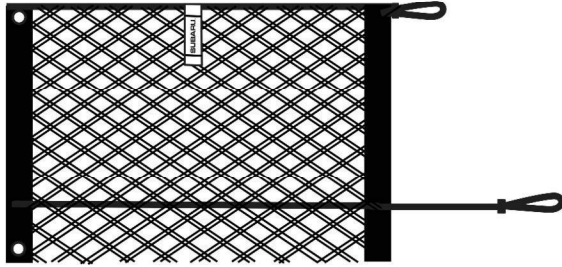

Remarque : cette trousse contient un filet droit et gauche

**B** **4X**

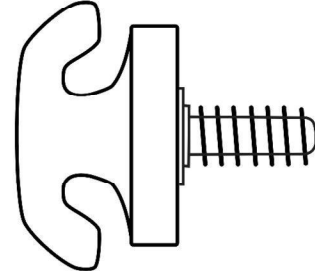

**C** **4X**

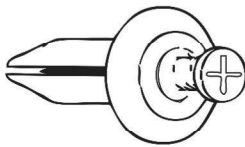

**D** **4X**

Remarque : Entretoise de nylon M5x22 OD









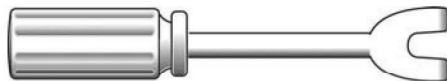



**E** **4X**



**OUTILS REQUIS**



**Signification des symboles :**

-  : Enlever
-  : Poser
-  : Déconnecter
-  : Connecter
-  : Emplacement de la marque
-  : Espace utilitaire côté conducteur
-  : Espace utilitaire côté passager
- T** : Couple de serrage
-  : Desserrer
-  : Jeter
-  : Recyclable
-  : Vue

**1**

Déposer le tapis de coffre.

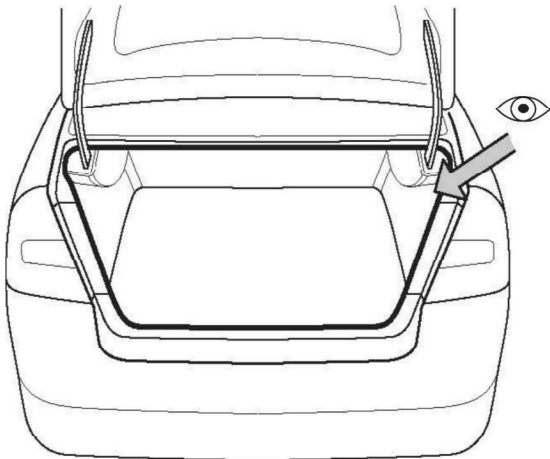
**2**

Repérer les capuchons indiqués.

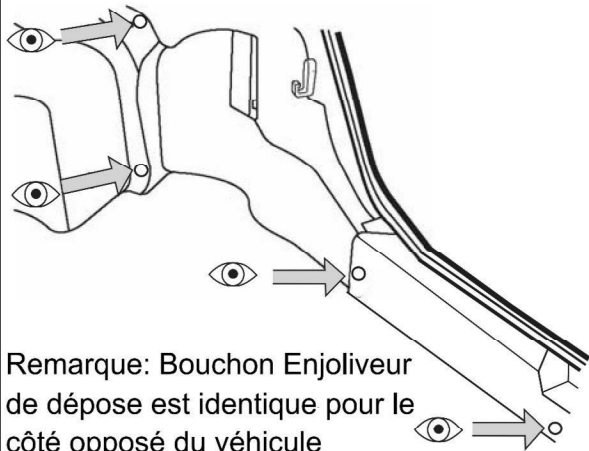

Remarque: Bouchon Enjoliveur de dépose est identique pour le côté opposé du véhicule

**3**

Enlever les capuchons du panneau et jeter.

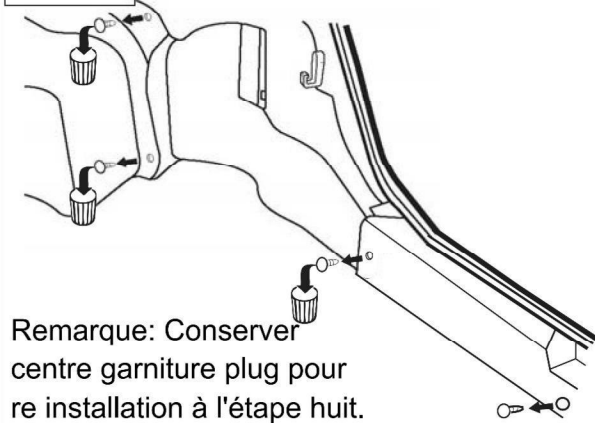

Remarque: Conserver centre garniture plug pour re installation à l'étape huit.

**4**

Repérer le crochet.

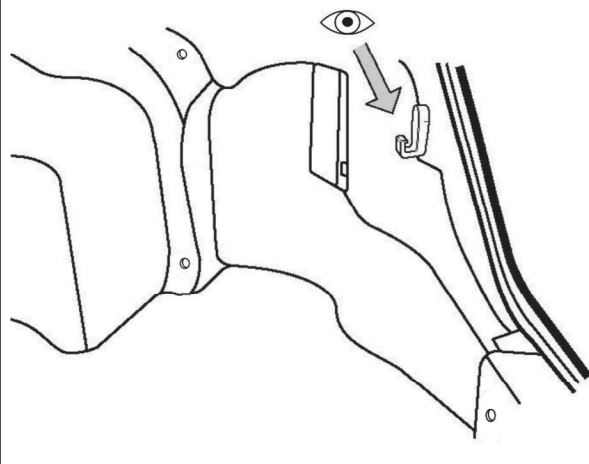
**5**

Faire pivoter le crochet de 90 degrés puis tirer dessus directement.

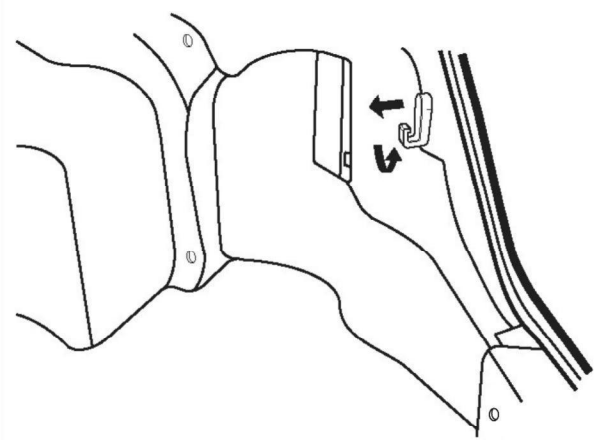
**6**

Soulever soigneusement la garniture latérale pour accéder au point de fixation de l'agrafe supérieure.

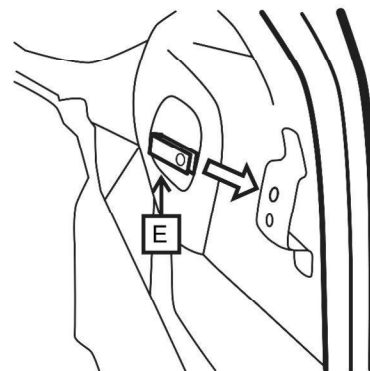

Remarque : L'installation est identique pour l'autre côté du véhicule.

**6a****7**

Soulever soigneusement la garniture pour accéder au point de fixation de l'agrafe inférieure.

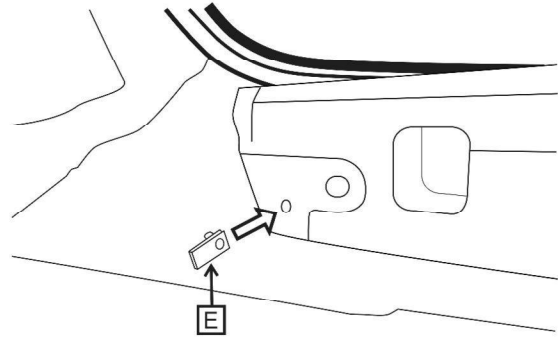
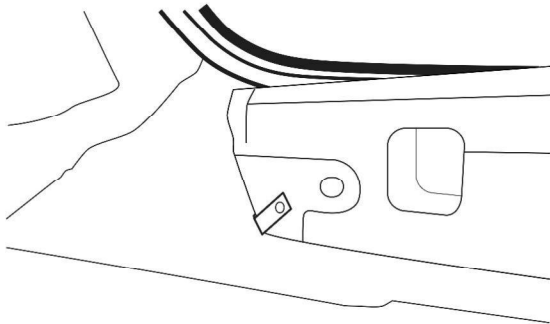
**7a****8**

Remarque : Réinstaller les panneaux de garnissage latéral et inférieur et le tapis de coffre.

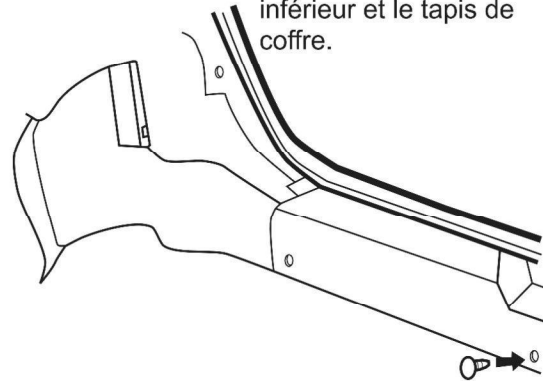

Remarque : Réinstaller le capuchon central conservé à l'étape 3.

**9**

Remarque : Fixer les entretoises sur l'ancrage en T et bien serrer manuellement aux points de fixation inférieur et supérieur comme montré sur la photo.

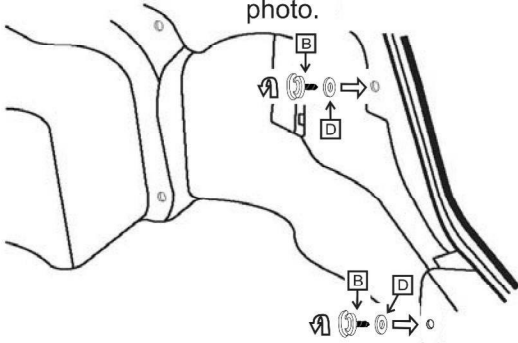

Remarque : L'installation est identique pour l'autre côté du véhicule

**10**

Pour terminer l'installation,  
 a) Pousser chaque fixation du panneau dans le filet jusqu'à ce qu'il soit bien fixé.  
 b) Insérer chaque anneau autour de l'ancrage en T comme montré sur la photo.

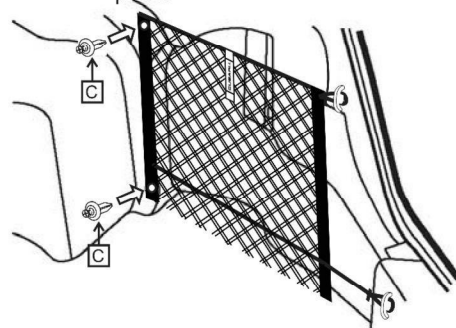

• Chaque filet a une capacité de 30 lb. dans des conditions normales de conduite. Non conçu pour restreindre des objets pendant la conduite tous terrains en cas d'accident.